

Type MG

Plug valves with threaded ends

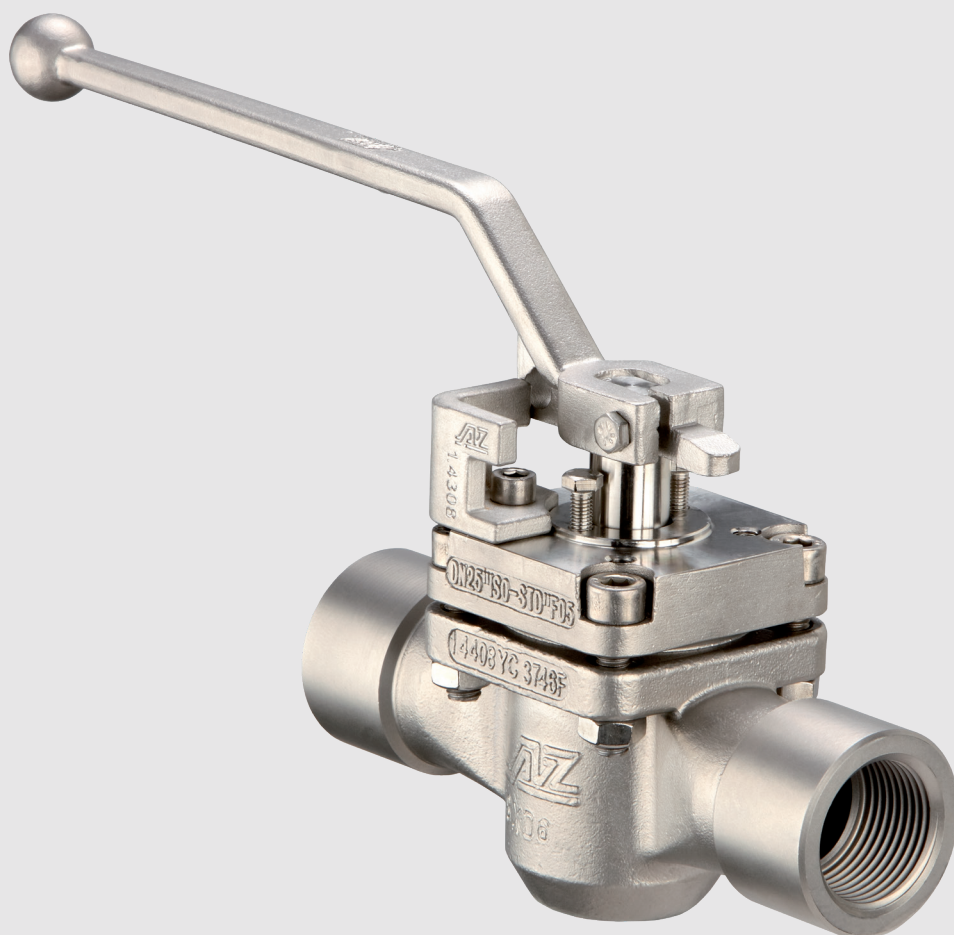

Type MG

Threaded-end plug valves



- Whitworth pipe thread
BSPP / BSPT
- American pipe thread NPT / NPTF
- other threads on request
- 2-way up to 5-way

NPS ½ - 3 / Class 150 - 300

Range of application:

-60 < T < 230/320°C

vacuum-capable

Design characteristics

- cast design
- parallel / tapered threads
- cavity-free
- maintenance-free, self-lubrication
- mounting-flange for actuators
acc. to ISO 5211
- tight chambering of all PTFE-parts
- no torsion of PTFE-sleeve
- easy accessible adjustment of
the plug
- delivery also with actuator
- low fugitive emission in line with
TA LUFT, ISO 15848 & API 641
requirements

Option

- heating jacket
- flushing device
- FDA compliant
- painting
- oil and grease-free assembly
- dairy connection acc. to DIN
11851



PT diagram, plug types, sealing
systems, material selection: see
catalogue part ENGINEERING

Type MG

Technical information

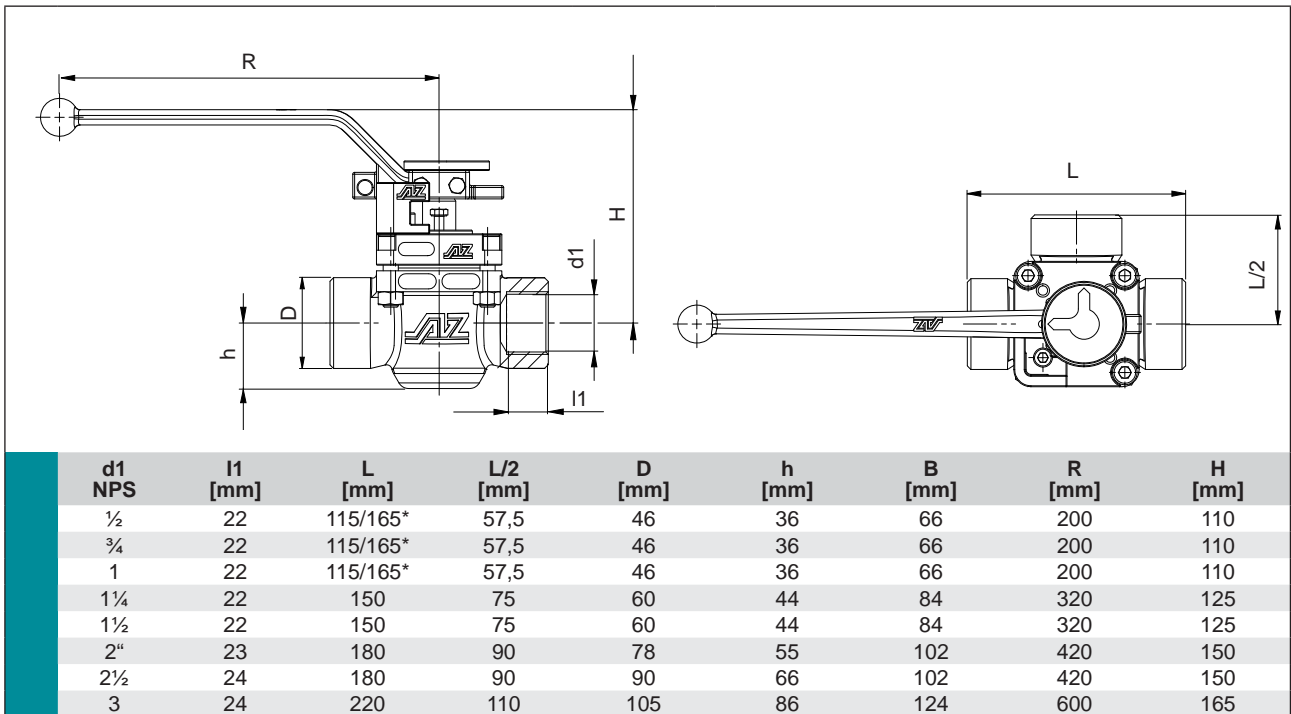

*) only for 2-way valves MG-2
larger nominal sizes on request

AZ-plug valve: the design principle

Key advantages

- free of cavities
- no contamination of process media
- adjustability of the plug and sealings
- maintenance-free due to self-lubricating and chemical-resistant PTFE-sleeve
- low emission design
- constant torque (Δp independent !)
- vacuum-capable

Tapered plug

- plug pressed into the PTFE-sleeve
- polished surface



Body

- tapered body interior
- integrated supporting ribs avoid rotation and coldflow of the sleeve
- large sealing surface





PTFE-sleeve

- mechanically locked into the valve body
- complete PTFE chambering
- robust, one-piece sleeve covers and protects the entire plug

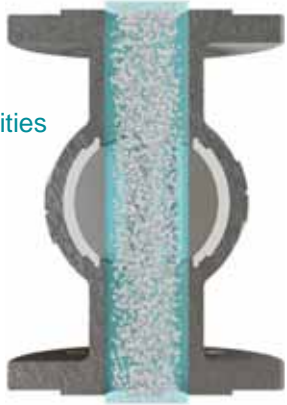
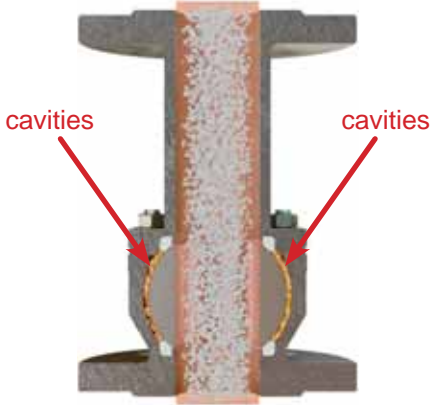

Cavity-free: suitable for all media

Technical comparison

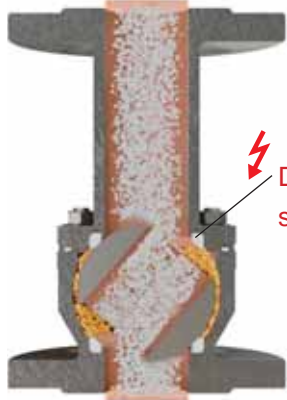
| AZ-plug valve | Ball valve |
|--|--|
| <p>Soft seated plug valve with PTFE-sleeve</p>  <p>Main sealing components</p> <ul style="list-style-type: none"> • metallic plug • sleeve | <p>Soft seated ball valve with PTFE sealing rings, floating ball</p>  <p>Main sealing components</p> <ul style="list-style-type: none"> • metallic ball • sealing rings |
| OPEN position | |
| <ul style="list-style-type: none"> • suitable for all media due to cavity-free design • sealing surfaces are completely protected  <p>free of cavities</p> | <ul style="list-style-type: none"> • critical for the following media due to design with cavities <ul style="list-style-type: none"> ○ corrosives: crevice corrosion ○ polymerizing: clogging ○ crystallizing: abrasion / clogging  <p>cavities</p> <p>cavities</p> |
| During operation | |
| <ul style="list-style-type: none"> • free of cavities, media cannot settle or be trapped • solids are pushed away • no contamination with old media  | <ul style="list-style-type: none"> • with cavities, media can settle or be trapped • solids cause abrasion of the sealing rings • contamination of process media  <p>Damage of the sealing rings</p> |

Safe and reliable tightness for years

Adjustable



- tapered plug design allows retightening of the sealing on site - if needed
- adjusting bolt even accessible with mounted actuator / gearbox

Several sealings to atmosphere

- 1 Primary: sleeve
- 2 Secondary: V-diaphragm/cover seal
- 3 Tertiary: stem packing (optional)



Detailed information about all certified AZ cover & stem sealing systems see chapter SEALING SYSTEMS

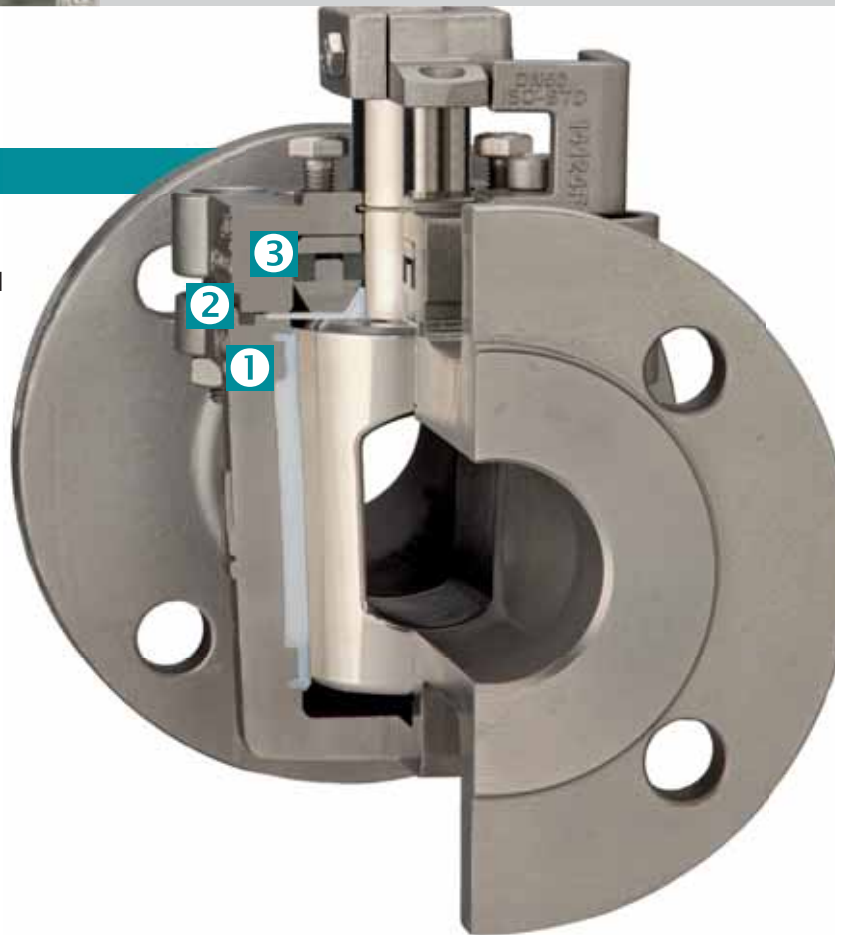

ISO cover

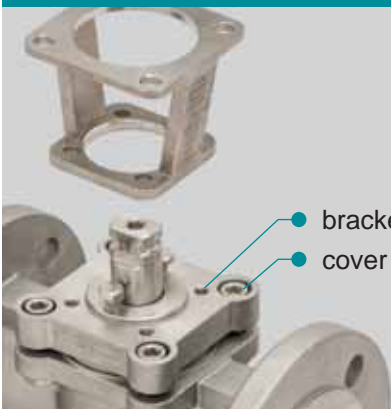

- pressure containing cover bolts separated from bracket boltings
- cover and bracket acc. to ISO 5211 for efficient actuator / gearbox assembly

Reduced and full bore design

Execution

Reduced bore

Type STANDARD

- compact valve (FF / weight)
- optimal torques for economic automation

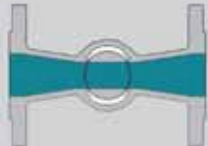

Full round bore

Type EXTRA

- maximum flow rate
- minimal pressure drop
- piggable (optional)

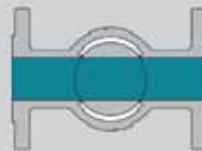

Type ISO-EXTRA

- excellent for abrasive, slurry and solid-containing applications
- maximum flow rate compared to other valve types with the same nominal size



Maximum flow rate

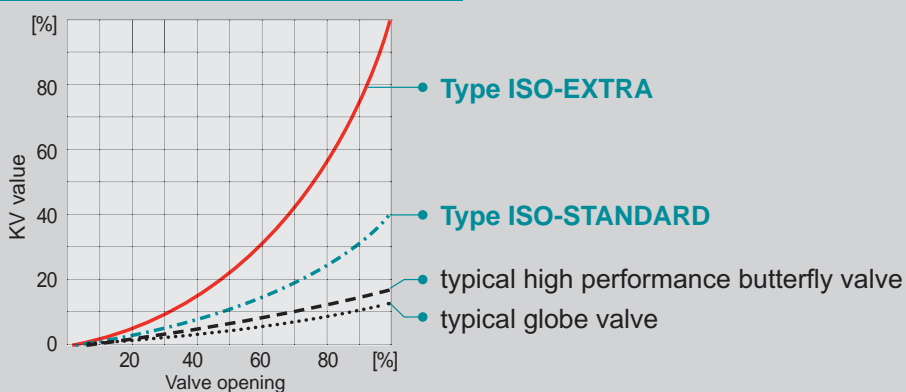

Options



Multi-port

- whole range of multi-port plugs for all configurations (up to 7-way)
- horizontal and vertical installation

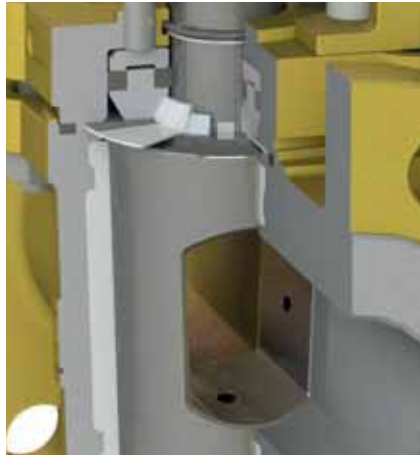

Vented options

- plug bottom
- plug upstream / downstream automatic pressure balance in case of thermal media expansion



System requirements

- **FDA** = Food and Drug Administration certifications and compliant materials
- **GMP** = Good-Manufacturing-Practice
- **CIP** = Clean-in-Place
- Polished internal surfaces, surface finish <math><0.8 \text{ Ra } \mu\text{m}</math> (<math><32 \text{ Ra } \mu\text{in}</math>)
- oil and grease free
- water-free



All connections possible

- flanges acc. to DIN, ASME, JIS etc.
- welded ends
- screwed and threaded ends
- combinations of connections
- oversize flanges
- compression fittings and ferrule ring couplings
- special connections



High and low temperature

- extended bonnet with sealing at the top
- stem extension for insulated valves



Modular operation concept

Bracket according to ISO 5211

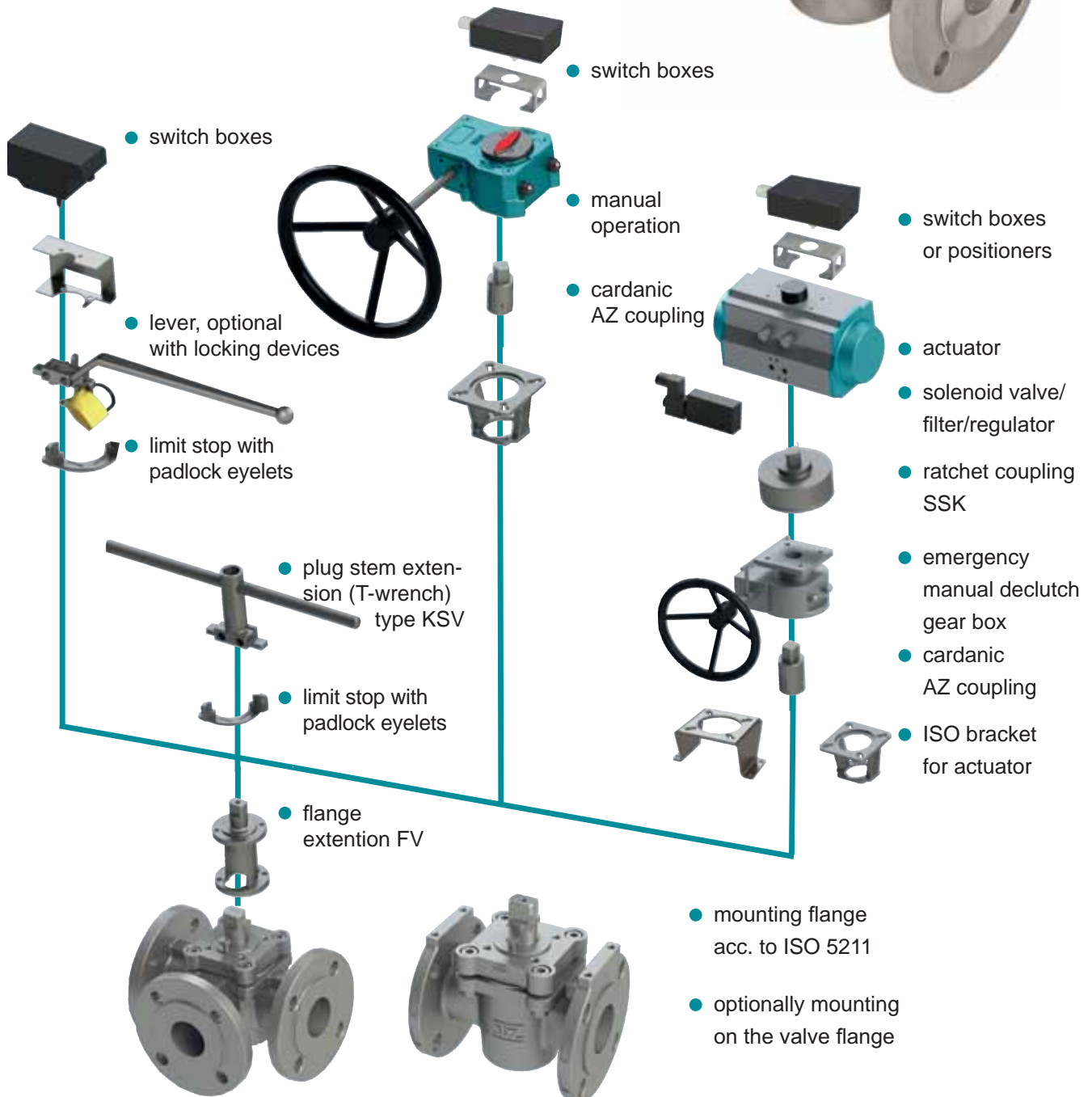
- standard installation of gearbox and actuator
- safe due to independent mounting of cover and bracket
- covering bonnet bolts to prevent opening of valve in service
- precise centering of the bracket to the plug stem due to adjusting ring
- easy inline plug adjustment during the process, screws are always accessible

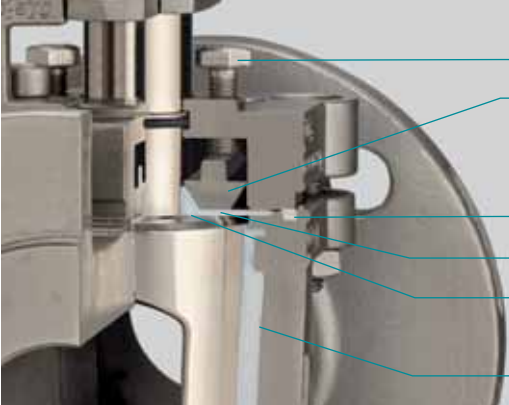

Cover and stem sealing systems suitable for general applications

| Type STANDARD | | | |
|---|--|--|--|
|  | <ul style="list-style-type: none"> ● plug adjustment ● thrust collar ● cover sealing (PTFE) ● stainless steel diaphragm ● Secondary sealing: V-diaphragm (PTFE), delta thrust collar (PTFE) ● Primary sealing: sleeve* | | |
| | Type FS2 | | |
| |  | <ul style="list-style-type: none"> ● plug & packing adjustment ● Tertiary sealing: Packing to atmosphere (graphite) ● thrust collar ● cover sealing (graphite) ● stainless steel diaphragm ● Secondary sealing: V-diaphragm (PTFE) and delta thrust collar (PTFE) ● Primary sealing: sleeve* | |
| | | Fire-Safe-sealing (API 607) | |
| | |  | <ul style="list-style-type: none"> ● plug & packing adjustment ● Tertiary sealing: Packing to atmosphere (PTFE) ● thrust collar ● cover sealing (PTFE) ● stainless steel diaphragm ● Secondary sealing: V-diaphragm, delta thrust collar (PTFE) ● Primary sealing: sleeve* |
| | | | Chemistry sealing |

*) The sleeve material has a decisive influence on the maximum operating temperature
Material selection acc. to PT-diagram

More safety for severe applications

*engineered.
fast.
dynamic.*

| Type FSN | Fire-Safe-sealing (API 607) |
|--|-----------------------------|
| <p>plug adjustment</p> <p>triple safety stem packing adjustment</p> <p>Tertiary sealing: triple safety stem packing (graphite)</p> <p>Secondary sealing: V-diaphragm (PTFE) and delta thrust collar (PTFE)</p> <p>cover sealing (graphite)</p> <p>Primary sealing: sleeve*</p> | |
| <p>Type FSN-EF</p> <p>Emission Free</p> <p>plug adjustment</p> <p>triple safety stem packing adjustment</p> <p>Quaternary sealing: three o-rings at the stem</p> <p>Tertiary sealing: triple safety stem packing</p> <p>Secondary sealing: V-diaphragm (PTFE) and delta thrust collar (PTFE)</p> <p>cover sealing (graphite)</p> <p>Primary sealing: sleeve*</p> | <p>NEW!</p> |
| <p>Type FSN-SL</p> <p>live-loaded</p> <p>plug adjustment</p> <p>o-rings protect the springs against corrosion</p> <p>triple safety stem packing adjustment</p> <p>disk springs (optionally made of Inconel)</p> <p>Tertiary sealing: triple safety stem packing (graphite)</p> <p>Secondary sealing: V-diaphragm (PTFE) and delta thrust collar (PTFE)</p> <p>cover sealing (graphite)</p> <p>Primary sealing: sleeve*</p> | |

*) The sleeve material has a decisive influence on the maximum operating temperature
Material selection acc. to PT-diagram

Material for **type CASN** and **CASN-SL** chemistry safety sealing: packing and cover sealing in PTFE

Special sealing systems

Chevron packing

- increases the contact pressure (when pressure builds up on the safety stem packing towards plug stem)
- for toxic and fugitive media
- high wear resistance



Type CL Chlorine / gas applications

- approved for chlorine applications and other toxic gases
- ideal for media with changing state of aggregate (e.g. liquid to gas, vice versa)
- vacuum capable



Detection ports for monitoring purpose of lethal gases (phosgene, etc.)

- detection ports for early recognition of potential leakages
- sniffing at sealing surfaces to atmosphere

- stem packing
- cover sealing
- flange sealing



Cover and stem sealing systems for lined plug valves

*engineered.
fast.
dynamic.*

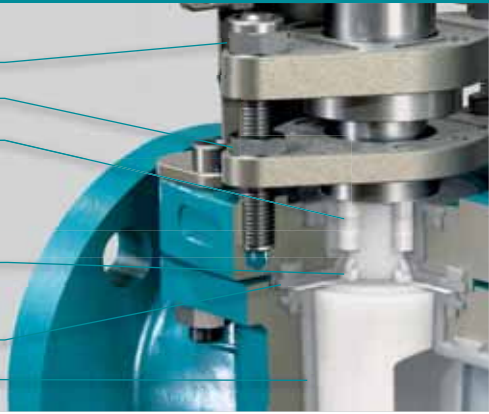
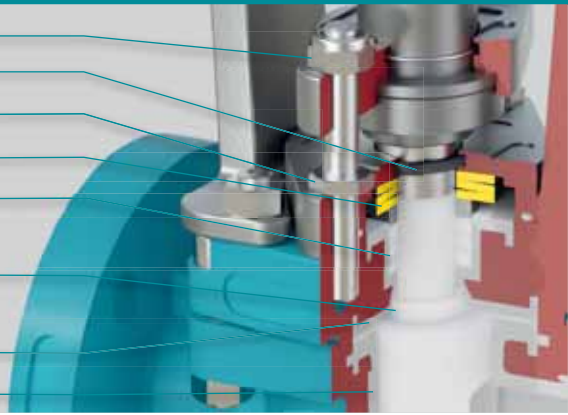
| Type CA 2A | Chemistry sealing | |
|---|--|--|
| <p>NEW!</p> | <ul style="list-style-type: none"> plug & packing adjustment stem O-ring Tertiary sealing: O-ring (FKM / FFKM) thrust collar stainless steel diaphragm | |
| | <ul style="list-style-type: none"> Secondary sealing: V-diaphragm & delta thrust collar (PTFE) Primary sealing: lined body | |
| |  | |
| | <hr/> | |
| | Type SAFE-LINED | Chemistry sealing |
| | <p>lined cover</p> | <ul style="list-style-type: none"> plug adjustment triple safety stem packing adjustment Tertiary sealing: triple safety stem packing (PTFE) to atmosphere Secondary sealing: V-diaphragm (PTFE), delta thrust collar (PTFE) lined cover Primary sealing: lined body* |
|  | | |
| <hr/> | | |
| Type SAFE-LINED-SL | | Chemistry sealing |
| <p>live-loaded</p> | | <ul style="list-style-type: none"> plug adjustment o-rings protect the springs against corrosion triple safety stem packing adjustment disk springs (optionally made of Inconel) Tertiary sealing: triple safety stem packing (PTFE) to atmosphere Secondary sealing: V-diaphragm (PTFE), delta thrust collar (PTFE) lined cover Primary sealing: lined body* |
| | |  |

*) Lining and plug material have a decisive influence on the maximum operating temperature
Material selection according to PT-diagram.

WORLD'S FIRST EMISSION FREE
plug valve certified acc. to **ISO 15848-1 / AH**
Type **FSN-EF**

NEW!



Fugitive
Emissions



Low-Emission according ISO 15848, TA-Luft & API 641



For all important information about ISO 15848, TA-Luft & API 641, as well as the current certificates, please refer to the "AZ Fugitive Emission" brochure



Latest information about ISO 15848 / API 641 / TA Luft see AZ Fugitive Emissions leaflet



Casting materials



| Material Group | Common Name | Casting Material | | | | | |
|------------------------------------|------------------|------------------|----------------------|--------------|-------|------------|--------|
| | | EN / DIN | Short name | Material-No. | ASTM | Grade | UNS |
| Carbon Steel / Ductile Iron | | | | | | | |
| Ductile Iron | SG Iron | EN 1563 | EN-GJS-400-18-LT | 5.3103 | A395 | - | F32800 |
| Carbon Steel | CS | EN 10213 | GP240GH | 1.0619 | A216 | WCB | J03002 |
| Low Temp. Carbon Steel | LTCS | EN 10213 | G17Mn5 | 1.1131 | A352 | LCB | J03003 |
| Low Temp. Carbon Steel | LTCS | EN 10213 | G21Mn5 | 1.1138 | A352 | LCC | J02505 |
| Stainless Steel | | | | | | | |
| Stainless Steel | Duplex 2205 | EN 10213 | GX2CrNiMoN22-5-3(4A) | 1.4470 | A995 | 4A-CD3MN | J92205 |
| Stainless Steel | Duplex 1B | EN 10213 | GX3NiCrMoCuN26-6-3-3 | 1.4517 | A995 | 1B-CD4MCuN | J93372 |
| Austenitic | SS | EN 10213 | GX5CrNi19-10 | 1.4308 | A351 | CF8 | J92600 |
| Austenitic | SS | EN 10213 | GX2CrNi19-11 | 1.4309 | A351L | CF3 | J92700 |
| Austenitic | SS | EN 10213 | GX5CrNiMo19-11-2 | 1.4408 | A351 | CF8M | J92900 |
| Austenitic | SS | EN 10213 | GX2CrNiMo19-11-2 | 1.4409 | A351 | CF3M | J92800 |
| Super Austenitic | Alloy 20 | EN 10213 | NiC420CuMo | 1.4500 | A351 | CN7M | N08007 |
| Super Austenitic | Alloy 20 mod. | EN 10213 | GX2NiCrMoCuN25-20 | 1.4536 | A743 | CN7MS | J94650 |
| Super Austenitic | AL6XN | - | - | - | A351 | CN3MN | J94651 |
| Superduplex | Superduplex 5A | EN 10213 | 25Cr-7Ni-Mo-N | 1.4469 | A995 | CE3MN | J93404 |
| Nickel Alloy | | | | | | | |
| | Monel/Alloy400 | DIN 17730 | G-NiCu30 Nb | 2.4365 | A494 | M35-1 | N24135 |
| | Hastelloy C mod. | - | - | - | A494 | CW6M | N30107 |
| | Hastelloy C | - | - | 2.4537 | A494 | CW12MW | N30002 |
| | Hastelloy C-276 | - | - | 2.4883 | - | - | - |
| | Hastelloy B-3 | - | - | - | - | - | - |
| | Inconel 600 | - | - | - | A494 | CY40 | N06040 |
| | Inconel 625 | - | - | - | A494 | CW6MC | N26625 |
| | Inconel 825 | - | - | - | A494 | CU5MCuC | N08826 |
| | Nickel | DIN 17730 | G-Ni 95 | 2.4170 | A494 | CZ100 | N02100 |
| Other Material Groups | | | | | | | |
| Tantalum | Tantalum | - | - | - | - | - | - |
| Titanium | Ti 2 | DIN 17865 | G-Ti 2 | 3.7031 | B367 | C-2 | R52550 |
| Zirconium | Zirconium 702 | - | - | - | B752 | 702C | - |
| Zirconium | Zirconium 705 | - | - | - | - | 705C | - |

All rights reserved, all indications without engagement, subject to modifications.

The use of these equivalents has to be evaluated on a case-by-case basis.

Other materials on request.

Equivalent forged and bar-stock materials

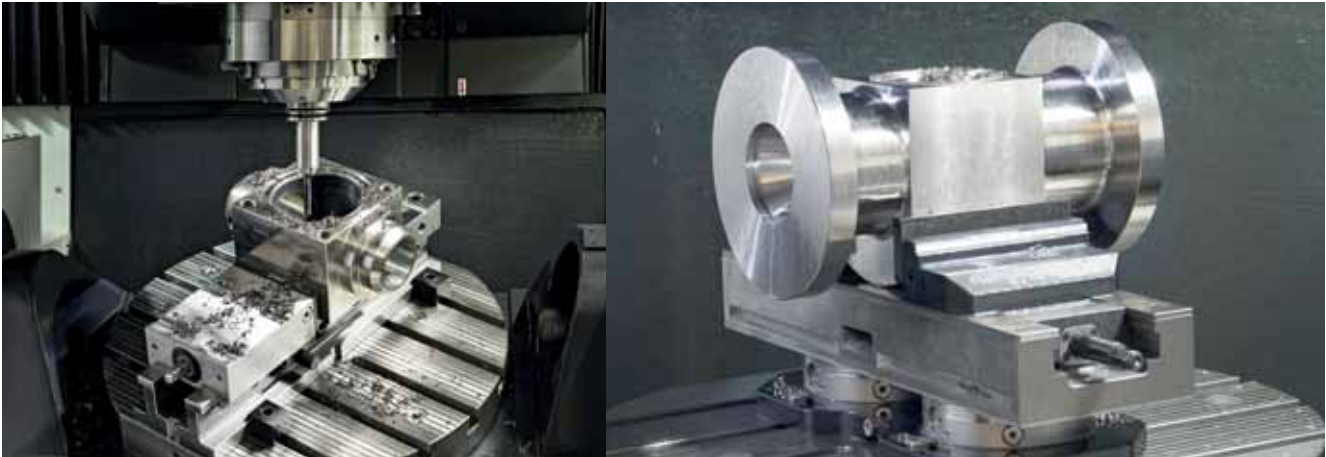

| Common Name | Mat.Nr. | Grade | Similar Forged Material | | | | | | Bar Material | |
|------------------------------------|---------|------------|-------------------------|--------------------|---------|---------|------------|--------|--------------|---------|
| | | | EN / DIN | Short Name | Mat.Nr. | ASTM | Grade | UNS | ASTM Short | |
| Carbon Steel / Ductile Iron | | | | | | | | | | |
| SG Iron | 5.3103 | - | EN 1563 | EN-GJS-400-18-LT | 5.3103 | A395-99 | 60-40-18 | - | - | - |
| CS | 1.0619 | WCB | EN 10213 | GP240GH | 1.0619 | A105 | A105 | - | - | - |
| LTCS | 1.1131 | LCB | - | - | - | A350 | LF2-Class1 | G10300 | - | - |
| LTCS | 1.1138 | LCC | - | - | 1.0566 | A350 | LF2-Class1 | G10250 | - | - |
| Stainless Steel | | | | | | | | | | |
| Duplex 2205 | 1.4470 | 4A-CD3MN | EN 10028-7 | X2CrNiMoN22-5-3 | 1.4462 | A182 | F51 | S32205 | A479 | S31803 |
| Duplex 1B | 1.4517 | 1B-CD4MCuN | EN 10028-7 | X2CrNiMoCuN25-5-3 | 1.4507 | A182 | F59 | S32520 | A479 | S32550 |
| SS | 1.4308 | CF8 | EN 10028-7 | X5CrNi18-10 | 1.4301 | A182 | F304 | S30400 | A276 | 304 |
| SS | 1.4309 | CF3 | EN 10028-7 | X2CrNi19-11 | 1.4306 | A182 | F304L | S30403 | A276 | 304L |
| SS | 1.4408 | CF8M | EN 10028-7 | X5C4NiMo17-12-2 | 1.4401 | A182 | F316 | S31600 | A276 | 316 |
| SS | 1.4409 | CF3M | EN 10028-7 | X2CrNiMo 17-12 | 1.4404 | A182 | 316L | S31603 | A276 | 316L |
| Alloy 20 | 1.4500 | CN7M | - | - | 2.4660 | B462 | N08020 | N08020 | B473 | N08020 |
| Alloy 20 mod. | 1.4536 | CN7MS | - | - | - | - | - | - | - | - |
| AL6XN | - | CN3MN | EN 10028-7 | X1NiCrMoCuN25-20-7 | 1.4529 | A182 | F62 | N08367 | B462 | N08367 |
| Superduplex 5A | 1.4469 | CE3MN | EN 10028-7 | X2CrNiMoN25-7-4 | 1.4410 | A182 | F63 | S32615 | - | - |
| Nickel Alloy | | | | | | | | | | |
| Monel/Alloy400 | 2.4365 | M35-1 | DN 17744 | NiCu30Fe | 2.4360 | B165 | Alloy 400 | N04400 | B164 | N04400 |
| Hastelloy C mod. | - | CW6M | - | - | - | A494 | - | - | - | - |
| Hastelloy C | - | CW12MW | - | NiMo16CrW | - | A494 | - | - | - | - |
| Hastelloy C-276 | - | - | DIN 17744 | NiMo16Cr15W | 2.4819 | B565 | N10675 | N10276 | B574 | N10276 |
| Hastelloy B-3 | - | - | DIN 17744 | NiMo29Cr | 2.4600 | B565 | N10675 | N10675 | B335 | N10675 |
| Inconel 600 | - | CY40 | DIN 17742 | NiCr15Fe | 2.4816 | B565 | N06600 | N06600 | B166 | N06600 |
| Inconel 625 | - | CW6MC | DIN 17744 | NiCr22Mo9Nb | 2.4856 | B565 | N06625 | N06625 | B446 | N06625 |
| Inconel 825 | - | CU5MCuC | DIN 17744 | NiCr21Mo | 2.4858 | B564 | N08825 | N08825 | B425 | N08825 |
| Nickel | 2.4170 | CZ100 | - | - | - | - | - | - | B160 | N02200 |
| Other Material Groups | | | | | | | | | | |
| Tantalum | - | - | - | - | - | B365 | TaW2,5 | R05252 | - | - |
| Ti 2 | 3.7031 | C-2 | DIN 17864 | Grade 2 | 3.7035 | B381 | F2 | R50400 | B348 | Grade 2 |
| Zirconium 702 | - | 702C | - | - | 6.0702 | B493 | R60702 | R60702 | B550 | R60702 |
| Zirconium 705 | - | 705C | - | - | - | B493 | R60705 | R60705 | B550 | R60705 |

All rights reserved, all indications without engagement, subject to modifications.

The use of these equivalents has to be evaluated on a case-by-case basis.

Other materials on request.

Lining materials



Lining materials

The high density, extremely resistant lining is at least 3 mm thick. New granulate is used exclusively, no refurbished regenerates or similar materials.

Fluoropolymer lining materials

- Body: PFA, PFA conductive and FEP
- Plug: PTFE, PFA, PFA conductive and FEP

| body lining | Combination of linings plug lining | T _{max} |
|----------------|---|------------------|
| PFA | PTFE ¹⁾ or special materials | 210°C / 410°F |
| PFA | PFA | 200°C / 392°F |
| PFA | FEP | 150°C / 302°F |
| PFA conductive | PFA conductive | 125°C / 257°F |
| FEP | FEP | 150°C / 302°F |
| FEP | PFA | 150°C / 302°F |

- 1) Plugs with PTFE lining only for two-way valves up to DN 100.
Plugs for multi-way valves not with PTFE lining available.

IMPORTANT NOTE

For demanding conditions, such as process temperatures exceeding 150°C / 302°F: Valve size, media phase, plug position & temperature (constant or fluctuating) may have an impact on the lifetime. Consult factory for proper selection of lining material, cover sealing type and special features.

Sleeve materials



| Category | Sleeve Material | Characteristics | Typical applications | T _{MAX} |
|-----------------|--------------------------------|--|---|------------------|
| PTFE | PTFE, virgin | low friction, very good sealing characteristic | standard sleeve material for most applications | 230°C / 446°F |
| RPTFE | PTFE-Glass | reinforced PTFE | additional stability for multiway valves with horizontal ports | 230°C / 446°F |
| | PTFE-Graphite | reinforced PTFE | high temperature applications | 250°C / 482°F |
| modified PTFE | TFM 1600* NXT 75* M 111* | chemically modified PTFE, reduced permeation, low friction | chemical applications where reduced permeability compared to PTFE is required | 250°C / 482°F |
| Special Sleeves | PTFE-P* NFCE* NCS* | high performance sleeve materials | severe service highest temperatures, high pressure, abrasive applications | 320°C / 608°F |
| PFA | PFA | reduced permeation | chemical applications where reduced permeability compared to PTFE is required | 200°C / 392°F |
| UHMW-PE | UHMW-PE | Ultra High Molecular Weight Polyethylene | radiation resistant, abrasive application | 80°C / 176°F |

*) sleeve material selection depending on availability at AZ manufacturing site

IMPORTANT NOTE

for demanding conditions, such as process temperatures exceeding 200°C / 392°F:
Valve size, media phase, plug position & temperature (constant or fluctuating) may have an impact on the lifetime. Consult factory for proper selection of sleeve material, cover sealing type and special features. For other sleeve materials not listed above: please contact your AZ sales representative.

PT Diagram, PN 16 - PN 100

PTFE sleeved plug valves

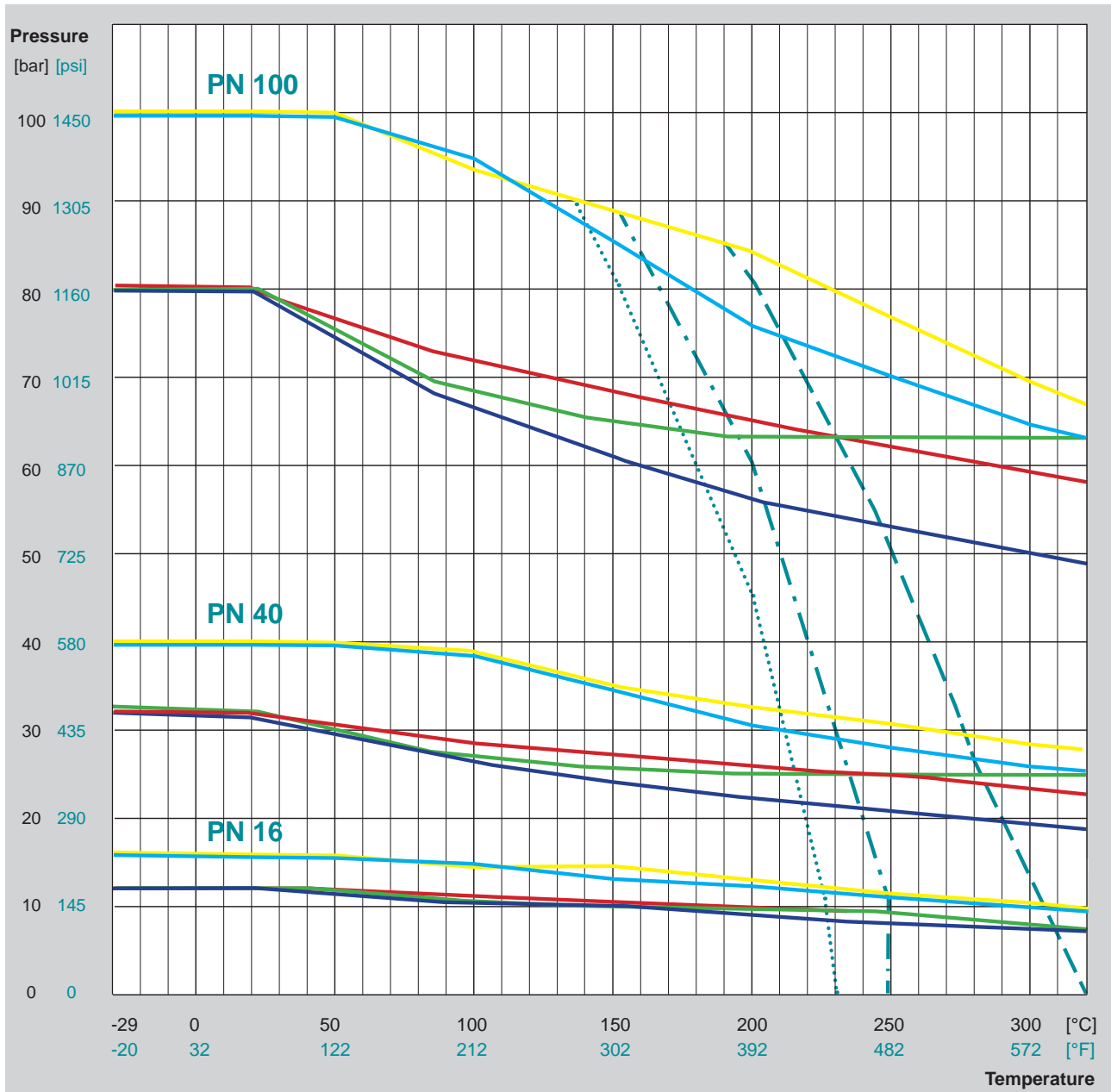

Body material

- EN 10213 - 1.0619 / Carbon Steel
 - EN 10213 - 1.4408 / Stainless Steel
 - EN 17744 - 2.4819 / Hastelloy
 - EN 17730 - 2.4365 / Monel 400
 - UNS N08007 - 1.4500 / Alloy 20
- other body materials on request

Sleeve material

- PTFE (virgin) / PTFE (glass) T_{max} 230°C / 446°F
 - .-.-.- TFM / NXT / M111 / PTFE graphite T_{max} 250°C / 482°F
 - PTFE-P / NFCE / NCS T_{max} 320°C / 608°F
- other sleeve materials on request

The data given are max. values according to EN 12516-1 and EN 1092-1.

IMPORTANT NOTE

for demanding conditions, such as process temperatures exceeding 200°C / 392°F: Valve size, media phase, plug position & temperature (constant or fluctuating) may have an impact on the lifetime. Consult factory for proper selection of sleeve material, cover sealing type and special features.

For temperatures < -29°C / -20°F, ($T_{limit} = -60°C / -76°F$) operating temperature, low-temperature carbon steel or austenitic stainless steels are required.

Subject to technical change without notice.

PT Diagram, Class 150 - Class 600

PTFE sleeved plug valves

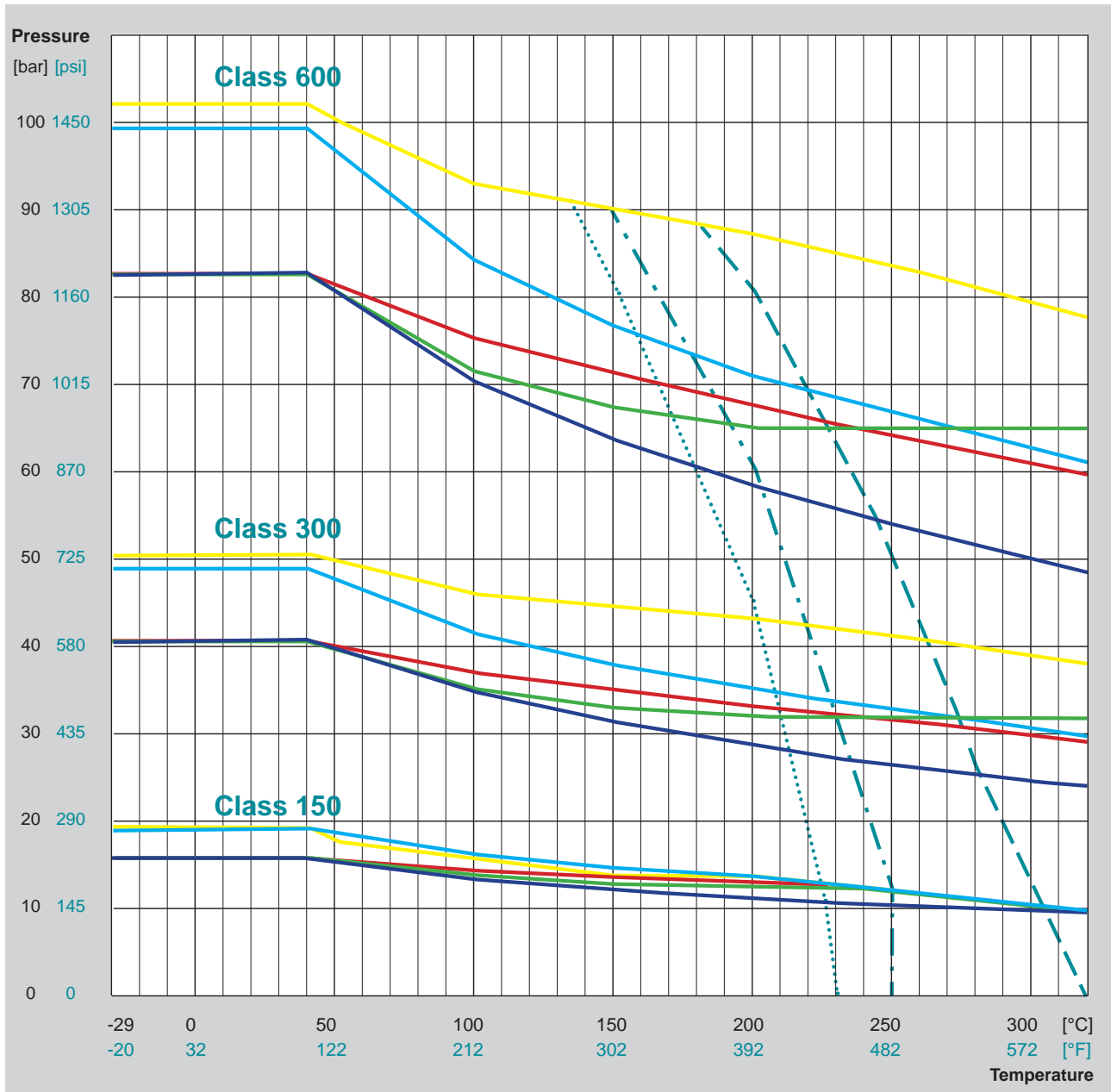

Body material

- ASTM A216 - WCB
- ASTM A351 - CF8M
- ASTM A494 - CW12MW / Hastelloy
- ASTM A494 - M35.1 / Monel 400
- ASTM A351 - CN7M Alloy 20
- other body materials on request

Sleeve material

- PTFE (virgin) / PTFE (glass) T_{max} 230°C / 446°F
- .-.- TFM / NXT / M111 / PTFE graphite T_{max} 250°C / 482°F
- PTFE-P / NFCE / NCS T_{max} 320°C / 608°F
- other sleeve materials on request

The data given are max. values according to ASME B16.34.

IMPORTANT NOTE

for demanding conditions, such as process temperatures exceeding 200°C / 392°F: Valve size, media phase, plug position & temperature (constant or fluctuating) may have an impact on the lifetime. Consult factory for proper selection of sleeve material, cover sealing type and special features.

For temperatures < -29°C / -20°F, ($T_{limit} = -60°C / -76°F$) operating temperature, low-temperature carbon steel or austenitic stainless steels are required.

Subject to technical change without notice.

PT Diagram High Pressure, PN 160

PTFE sleeved plug valves with trunnion mounted design

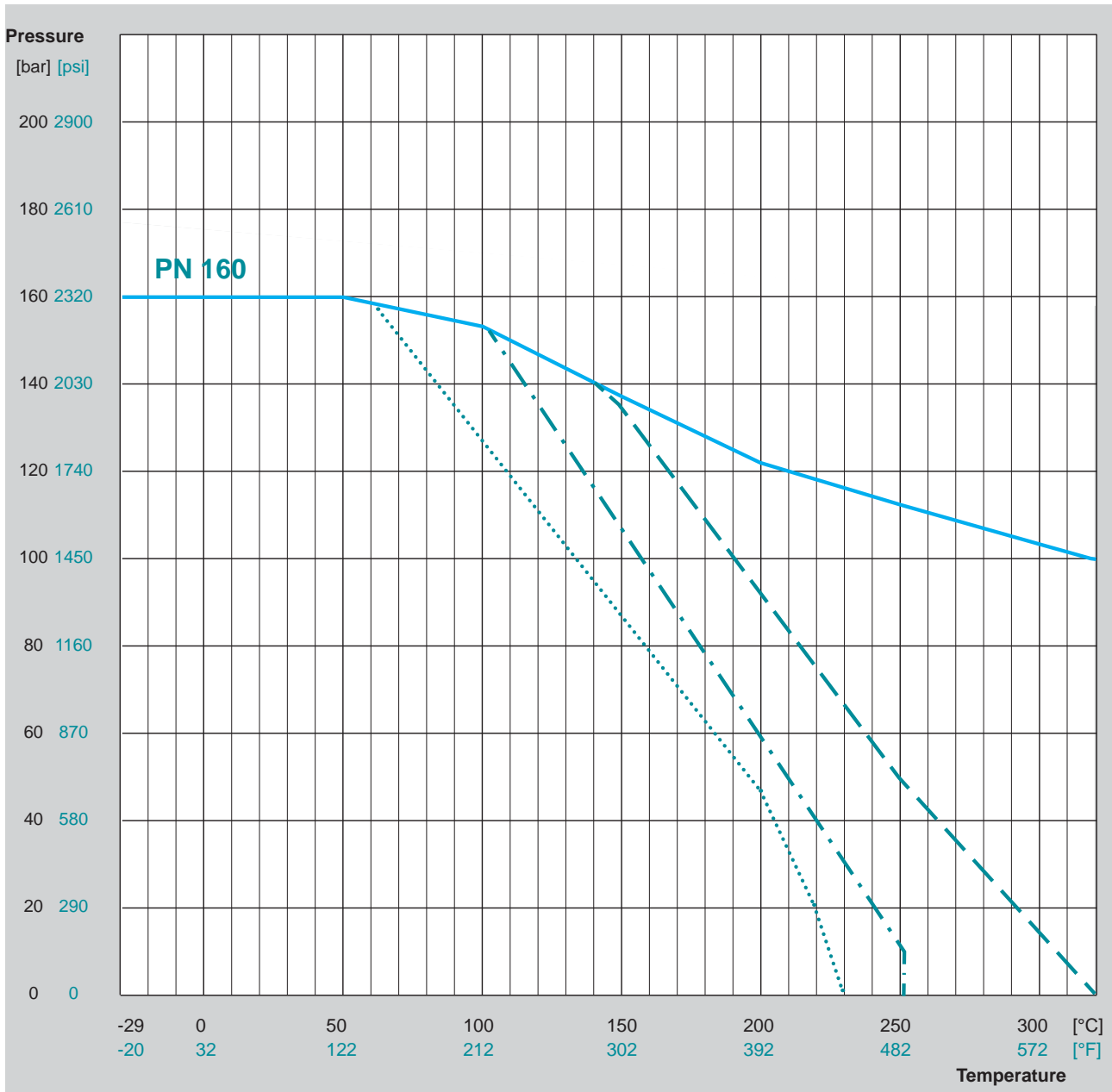

Body material (in line with EN 12516-1 and EN 1092-1)

- EN 10213 - 1.4408 / Stainless Steel
- other body materials on request

Sleeve material

- PTFE (virgin) / PTFE (glass) T_{max} 230°C / 446°F
- . - . TFM / NXT / M111 / PTFE graphite T_{max} 250°C / 482°F
- PTFE-P / NFCE / NCS T_{max} 320°C / 608°F
- other sleeve materials on request

The data given are max. values according to EN 12516-1 and EN 1092-1.

IMPORTANT NOTE

for demanding conditions, such as process temperatures exceeding 200°C / 392°F: Valve size, media phase, plug position & temperature (constant or fluctuating) may have an impact on the lifetime. Consult factory for proper selection of sleeve material, cover sealing type and special features.

For temperatures < -29°C / -20°F, ($T_{limit} = -60°C / -76°F$) operating temperature, low-temperature carbon steel or austenitic stainless steels are required.

Subject to technical change without notice.

PT Diagram High Pressure, Class 900

PTFE sleeved plug valves with trunnion mounted design

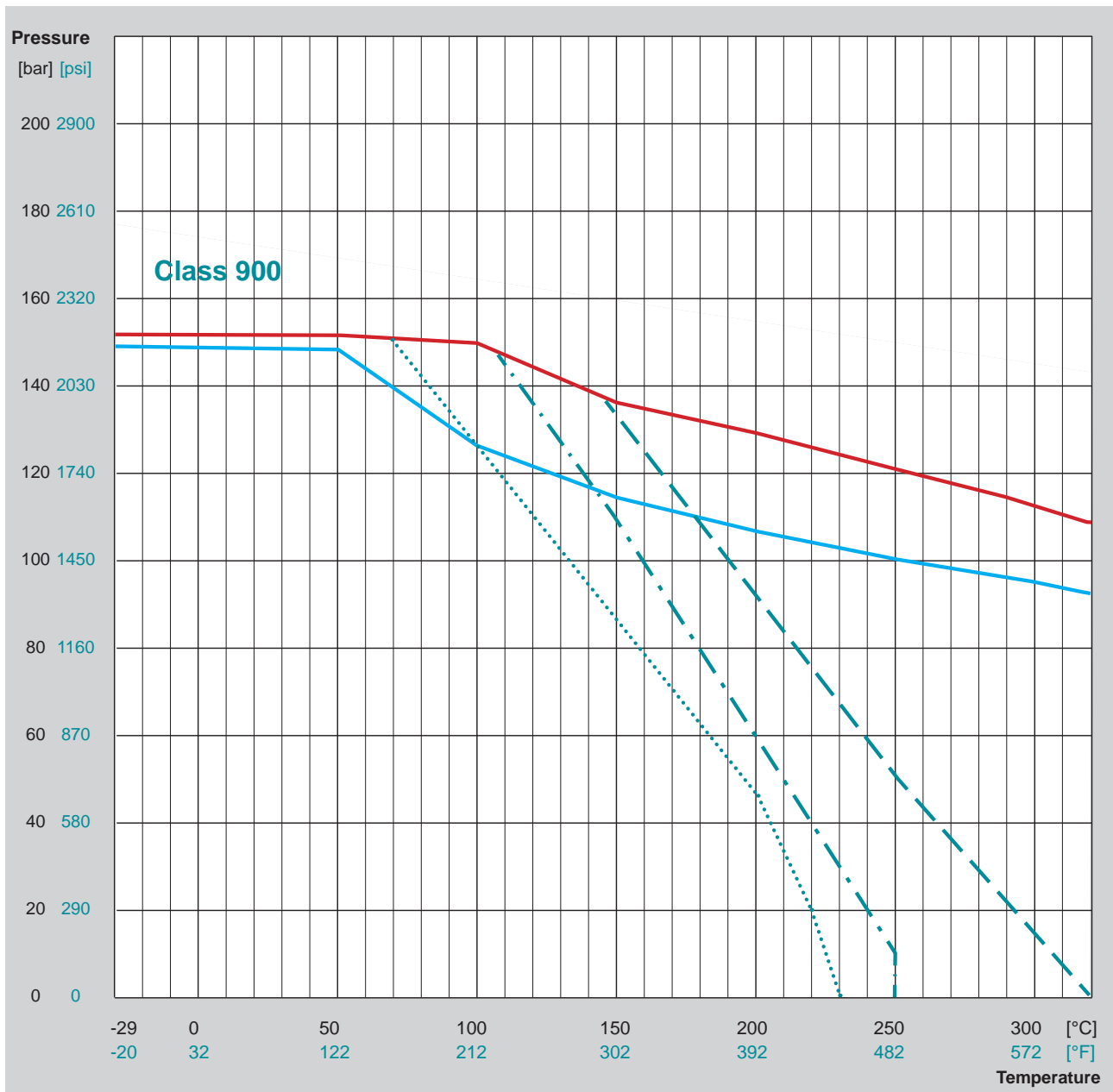

Body material (in line with ASME B16.34)

- ASTM A351 - CF8M / Stainless Steel
- ASTM A995 - CD3MN / Superduplex
- other body materials on request

Sleeve material

- ⋯⋯⋯ PTFE (virgin) / PTFE (glass) T_{max} 230°C / 446°F
- · - · - TFM / NXT / M111 / PTFE graphite T_{max} 250°C / 482°F
- - - - - PTFE-P / NFCE / NCS T_{max} 320°C / 608°F
- other sleeve materials on request

The data given are max. values according to ASME B16.34.

IMPORTANT NOTE

for demanding conditions, such as process temperatures exceeding 200°C / 392°F: Valve size, media phase, plug position & temperature (constant or fluctuating) may have an impact on the lifetime. Consult factory for proper selection of sleeve material, cover sealing type and special features.

Subject to technical change without notice.

For temperatures < -29°C / -20°F, ($T_{limit} = -60°C / -76°F$) operating temperature, low-temperature carbon steel or austenitic stainless steels are required.

PT Diagram, PN 10 - PN 40 lined valves

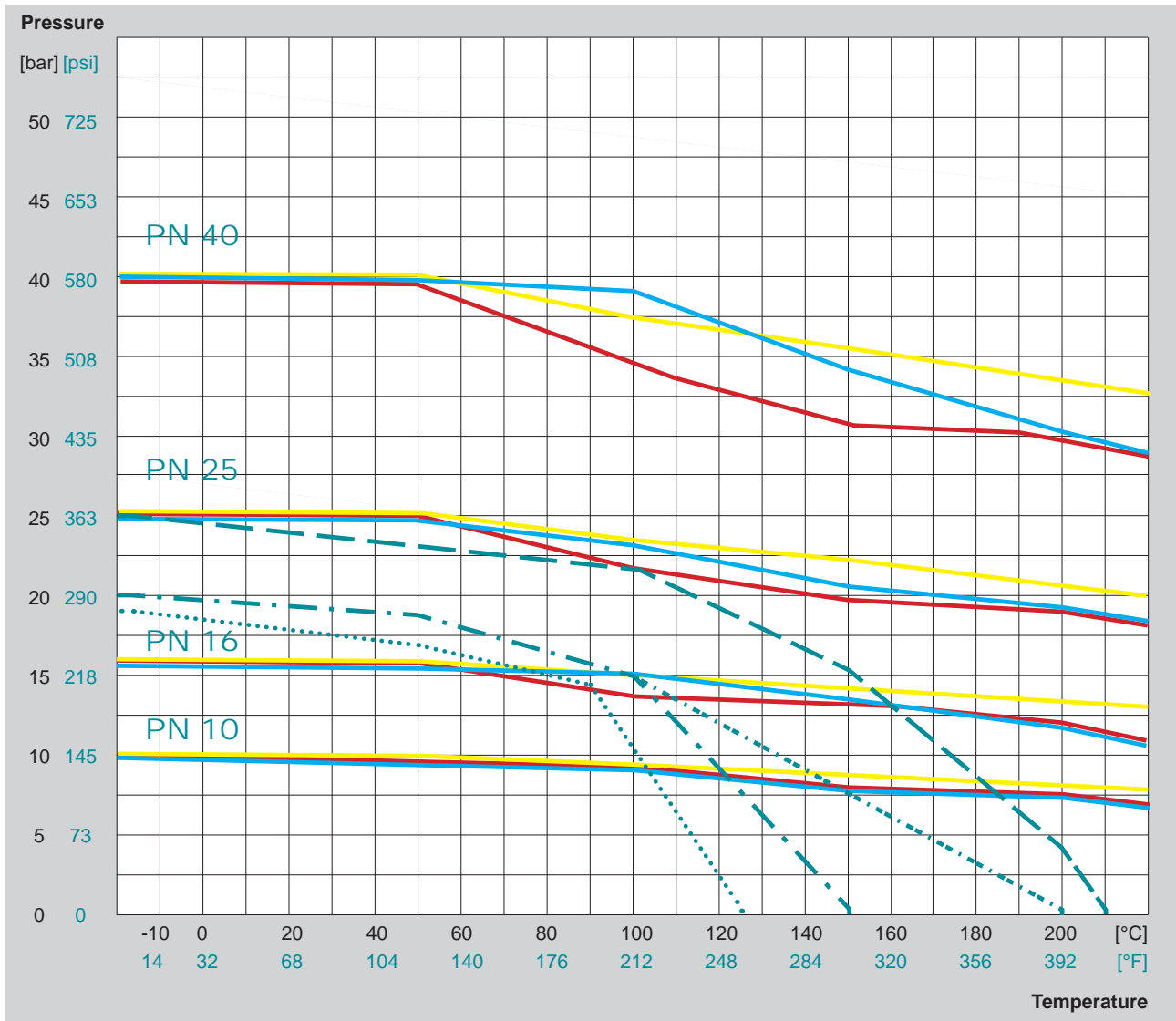

Body material

- EN 10213 - 1.0619 / Carbon Steel
 - EN 10213 - 1.4408 / Stainless Steel
 - EN 1563 - EN-GJS-400-18-LT / Ductile Iron
- other body materials on request

Lining combination

| | Body | Plug / Ball | T _{MAX} |
|---|-----------------------------------|------------------|------------------|
| - - - | PFA | PTFE or special* | 210°C / 410°F |
| | PFA | PFA | 200°C / 392°F |
| - . - . - | all combinations with PFA and FEP | | 150°C / 302°F |
| | PFA conductive | PFA conductive** | 125°C / 257°F |

*) Special materials (metallic) for plugs without lining on request

***) Material combination PFA / FEP possible

The data given are max. values according to EN 12516-4.

IMPORTANT NOTE

for demanding conditions, such as process temperatures exceeding 150°C / 302°F: Valve size, media phase, plug position & temperature (constant or fluctuating) may have an impact on the lifetime. Consult factory for proper selection of lining material, cover sealing type and special features.

Maximum breakaway torque depending on material combinations according to the technical data sheets of the plug valve.

Subject to technical change without notice.

PT Diagramm, Class 150 - Class 300 lined valves

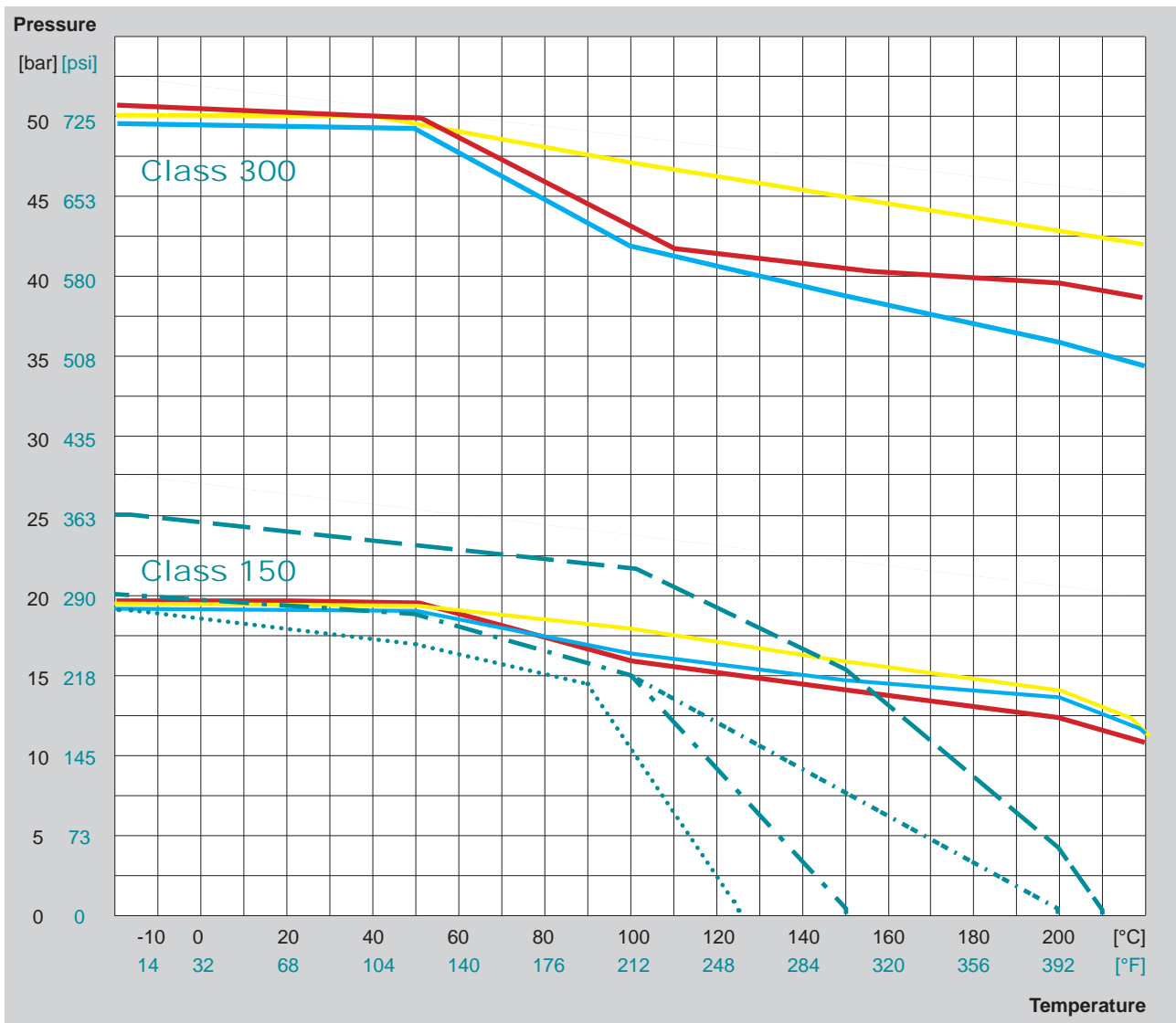

Body material

- ASTM A216 - WCB
- ASTM A351 - CF8M / Stainless Steel
- ASTM A395 / Ductile Iron
- other body materials on request

Lining combination

| | Body | Plug / Ball | T _{MAX} |
|--|-----------------------------------|------------------|------------------|
| - - - | PFA | PTFE or special* | 210°C / 410°F |
| - · - · - | PFA | PFA | 200°C / 392°F |
| - · - · - · - | all combinations with PFA and FEP | | 150°C / 302°F |
| · · · · · | PFA conductive | PFA conductive** | 125°C / 257°F |

*) Special materials (metallic) for plugs without lining on request

**) Material combination PFA / FEP possible

The data given are max. values according to ASME B16.34 / B16.42.

IMPORTANT NOTE

for demanding conditions, such as process temperatures exceeding 150°C / 302°F: Valve size, media phase, plug position & temperature (constant or fluctuating) may have an impact on the lifetime. Consult factory for proper selection of lining material, cover sealing type and special features.

Maximum breakaway torque depending on material combinations according to the technical data sheets of the plug valve.

Subject to technical change without notice.

Plug types: two-way and multi-port for standard reduced and full bore design



- position indicator for all multi-way valves welded on lever or stem extension
- Lined plug valves: multi-way plugs only with PFA / FEP plug lining or made of special materials. Two-way plugs with PTFE lining up to DN 100 / NPS 4 available

Recommendation for three-way valves type F-3-S with vertical outlet (longer life-time compared to type F-3-W with horizontal outlet)

Options

Plugs made of special materials or special designs, e.g. with flushing devices, vent holes in plug bottom or plug upstream / downstream side

| 2-way | Plug type | Pos. I = 0° | Pos. II = 90° | Pos. III = 180° | Pos. IV = 270° |
|-----------------------|-----------|-------------|---------------|-----------------|----------------|
| | | | | | |
| Type F-2-ISO-STANDARD | | | | | |







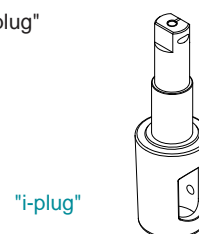



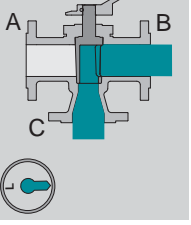
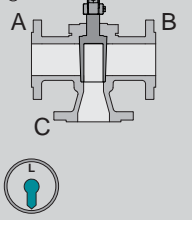
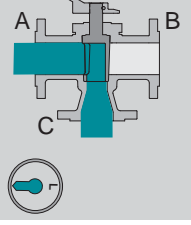

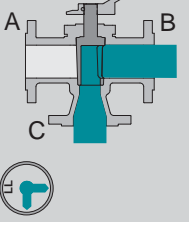
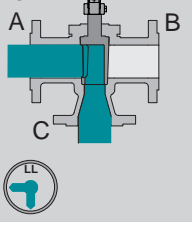

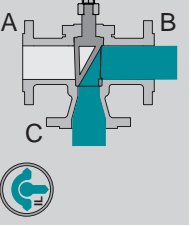
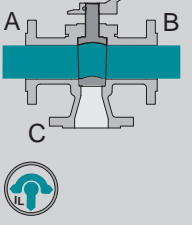
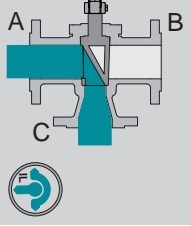
Type F-2-ISO-STANDARD-A

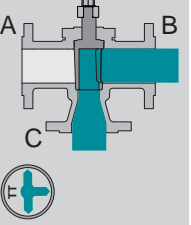
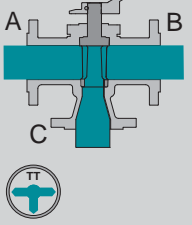
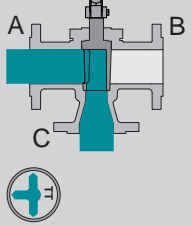
*) For highly expanding media AZ recommends the "i-plug" (relief hole and open plug bottom)

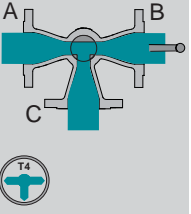
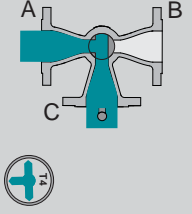
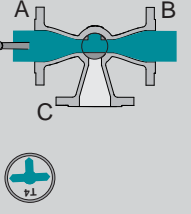
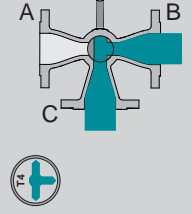

Plug types: 3-way valve for STANDARD and EXTRA design

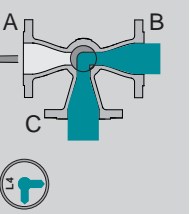
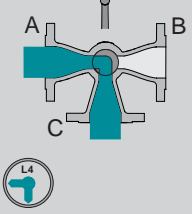
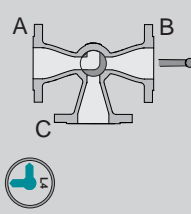
| Plug type | Pos. I = 0° | Pos. II = 90° | Pos. III = 180° | Pos. IV = 270° | 3-way (vertical) |
|--|---|---|---|----------------|---|
| L  |  |  |  | |  Type F-3-S-ISO-STANDARD |
| LL  |  |  | | | |
| IL*  |  |  |  | |  Type F-3-S-ISO-STANDARD-A |
| TT  |  |  |  | | |

| Plug type | Pos. I = 0° | Pos. II = 90° | Pos. III = 180° | Pos. IV = 270° | 3-way (horizontal) |
|--|---|---|---|--|--|
| T4  |  |  |  |  |  Type F-3-W-ISO-STANDARD |
| L4  |  |  |  | |  Type F-3-W-ISO-STANDARD-A |

*) for EXTRA valves with IL-plug, F-3-W-EXTRA with T4-plug is recommended (higher flowrate)
Lined valves: the IL-plug is only available in special materials

Plug types 3-way (120°) valves and 4-way valves for STANDARD and EXTRA design

3-way (120°) type 3-W-120:

- min. cross section guaranteed (switching phase)
- piggable execution on request
- minimum flow guaranteed

transflow design

3-way (120°) type 3-WP-120

- with positive overlap
- flow interruption / isolation











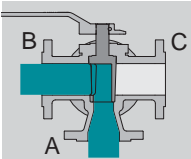
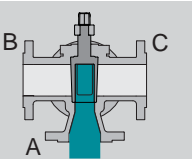
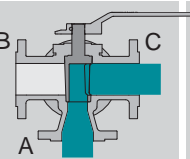
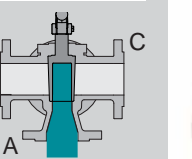

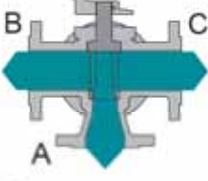

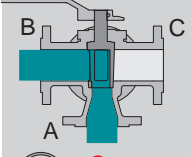
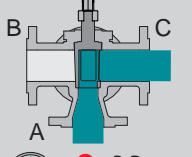
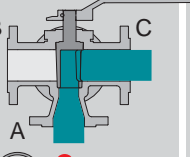
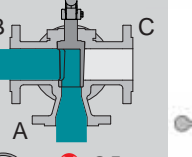
positive overlap

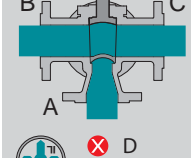
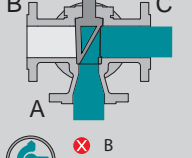
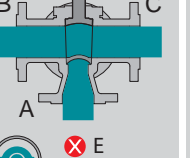
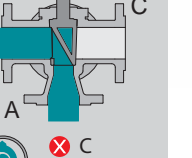
| 3-way (120°) | Plug type | Pos. I = 0° | Pos. II = 120° | Pos. III = 240° | |
|--------------|-----------------|-------------|----------------|-----------------|--|
| | L120 | | | | |

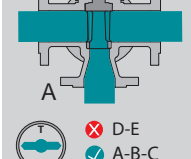
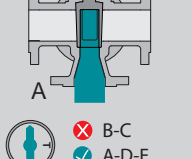
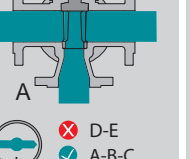
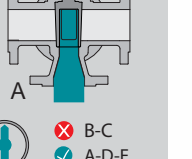
| 4-way | Plug type | Pos. I = 0° | Pos. II = 90° | Pos. III = 180° | Pos. IV = 270° |
|-----------------------------------|----------------|--------------------|--------------------|--------------------|--------------------|
| Type F-4-ISO-STANDARD | L4 | ✓ B-E ✗ C-D | ✗ B-D ✓ C-E | ✗ B-E ✓ C-D | ✗ C-E ✓ B-D |
| | T4 | ✗ D ✓ B-C-E | ✗ B ✓ C-D-E | ✗ E ✓ B-C-D | ✗ C ✓ B-D-E |
| | LL4 | ✓ B-E + C-D | ✓ B-D + C-E | | |

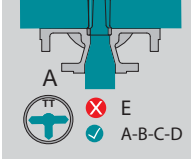
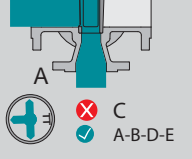
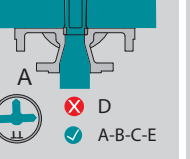
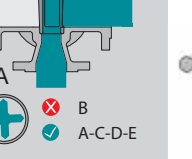
open
 closed

Plug types 4-way (special) and 5-way valves for STANDARD and EXTRA design

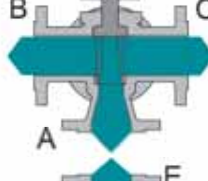
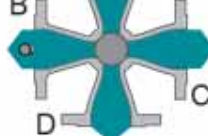
| Plug type | Pos. I = 0° | Pos. II = 90° | Pos. III = 180° | Pos. IV = 270° | 4-way (special) / 5-way |
|--|---|---|---|--|---|
| L  |  A B C ✓ A-B ✗ C-D-E |  A B C ✓ A-E ✗ B-C-D |  A B C ✓ A-C ✗ B-D-E |  A B C ✓ A-D ✗ B-C-E |  Type F-4-Special-ISO-STANDARD   |
| LL  |  A B C ✓ A-B-E ✗ C-D |  A B C ✓ A-C-E ✗ B-D |  A B C ✓ A-C-D ✗ B-E |  A B C ✓ A-B-D ✗ C-E | |
| IL  |  A B C ✓ A-E + B-C ✗ D |  A B C ✓ A-C + D-E ✗ B |  A B C ✓ A-D + B-C ✗ E |  A B C ✓ A-B + D-E ✗ C | |
| T  |  A B C ✓ A-B-C ✗ D-E |  A B C ✓ A-D-E ✗ B-C |  A B C ✓ A-B-C ✗ D-E |  A B C ✓ A-D-E ✗ B-C | |
| TT  |  A B C ✓ A-B-C-D ✗ E |  A B C ✓ A-B-D-E ✗ C |  A B C ✓ A-B-C-E ✗ D |  A B C ✓ A-C-D-E ✗ B | |
|  open  closed | | | | |  Type F-5-ISO-STANDARD   |



AZ plants

Headquarters Germany

AZ Armaturen GmbH
Waldstrasse 7
D-78087 Moenchweiler
Phone: +49 / 7721 / 7504-0
sales@az-armaturen.com
www.az-armaturen.com

Plant Brazil

AZ Armaturen do Brasil LTDA.
Av. Osvaldo Berto, 600
CEP 13255-405 Itatiba - SP
Phone: +55 / 11 / 452499-50 / -51
az@az-armaturen.com.br
www.az-armaturen.com.br

Plant China

AZ Armaturen (Taicang) Co., Ltd.
No. 1 Zhengzhou Road
215400 Taicang City
Phone: +86 / 512 / 53667600
info@az-armaturen.cn
www.az-armaturen.cn

Plant South Africa

AZ Armaturen South Africa PTY LTD.
28 Derick Coetzee Street
Boksburg 1459
Phone: +27 / 11 / 397 3665
sales@az-armaturen.co.za
www.az-armaturen.co.za

Plant USA

AZ VALVES North America L.P.
18702 Intercontinental Crossing Drive
Houston, TX 77073
Phone: +1 / 832 / 827 2163
sales@azvalves.com
www.azvalves.com

Plant Saudi Arabia

AZ Valves Arabia Manufacturing Co.
Building No. 4066
Street 26, Cross 09
Dammam, Kingdom of Saudi Arabia
Phone: +966 / 13 835 1880
info@azvalves.com.sa

AZ services

Europe

- Germany (Moenchweiler & Rhineland)
- France (Lyon/ Bourg-lès-Valence)
- Great Britain (York/Roecliffe)
- Italy (Milan/Caltignaga)
- Poland (Warsaw/Opoczno)
- The Netherlands (Amsterdam)
- Russia (St. Petersburg)

America

- USA (Houston/TX)
- Brazil (São Paulo, Itatiba & Belem)
- Chile (Santiago de Chile)
- Mexico (Mexico-City)
- Peru (Lima)

Middle East

- Saudi Arabia (Dammam)

Asia

- China (Taicang)
- South Korea
- Thailand (Rayong)
- Vietnam (Hanoi)

Africa

- South Africa (Johannesburg)



Detailed addresses
on our website

www.az-armaturen.com